

MAXIMATOR®

maximum pressure

Technical Data Sheet

GPD60

» Oil and Water Service

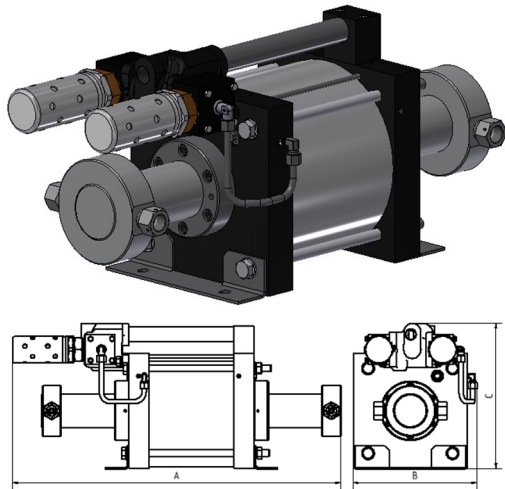

GPD60

double acting, single air drive head

Technical Data:

Air drive pressure:	1 - 10 bar / 14.5 - 145 psi
Calculated working pressure:	600 bar / 8700 psi
Pressure ratio:	1:60
Displacement volume/double stroke:	257 cm³ / 15.7 cu.inch

Connections:

Inlet:	BSP 3/4"
Outlet:	BSP 3/4"
Air drive:	BSP 3/4"
Maximum operating temperature:	60°C
Net weight:	58 kg

Pressure and flow performances, please see enclosed graph.



Pumps of the GPD Series that are marked with an EX sign and are supplied with a declaration of conformity as defined in 94/9/EC may be used in areas subject to explosion hazards. They are in conformity to Group II Category 2G Explosion group IIC constructive safety.

Wetted materials of construction:

Seal package:	GPD 60: UHMWPE, FKM
Pump Body:	1.4542
Piston:	1.4542
Fittings:	1.4542

Approximate Dimensions:

A:	778 mm
B:	294 mm
C:	343 mm

Available Options:

Inlet and Outlet piping to one common inlet and one common outlet port

Available Accessories:

Air control units with filter pressure regulator, control pressure gauge and shut off valve:	GPD60 with C2
To protect the pump against excessive outlet pressures or to limit the outlet pressure, a safety valve can be fitted to the air control unit in the air drive line.	GPD60 with C2/SV-air (The required outlet pressure has to be indicated.)

Please consult factory for more information. All technical and dimensional information subject to change. All General Terms and Conditions of sale, including limitations of our liability, apply to all products and services sold.

Leistungsdiagramm/Performance Graph GPD 60

Prüfflüssigkeit/Test Liquid: Wasser-Öl-Emulsion/Water Oil Emulsion ca. 1 - 10 cst

