

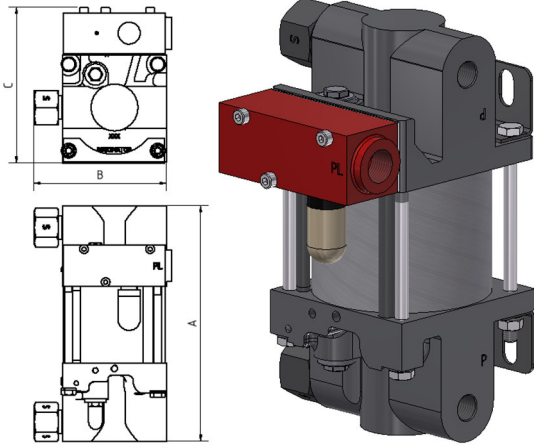

Technical Data Sheet

MO22D

» Oil service



MO22D
double acting, single air drive head
(Standard= Side inlet)

Technical Data:

Air drive pressure:	1 - 10 bar / 14.5 - 145 psi
Calculated working pressure:	280 bar / 4060 psi
Pressure ratio:	1:28
Displacement volume/double stroke:	9.2 cm ³ / 0.56 cu.inch

Connections:

Inlet:	3/8" BSP
Outlet:	1/4" BSP
Air drive:	3/8" BSP
Maximum operating temperature:	60°C
Net weight:	4.5 kg

Pressure and flow performances, please see enclosed graph.

Wetted materials of construction:

Top cap:	0.7050
Air cylinder:	3.3206
Seal package:	Polyurethane, NBR
Pump Body:	0.7050
Piston:	1.4112

Approximate Dimensions:

A:	185.5 mm
B:	108 mm
C:	122.5 mm

Available Options:

Special inlet and outlet ports, i.e. NPT:	MO22D-NPT
Special seal material to handle special fluids on request.	

Available Accessories:

Air control units with filter pressure regulator, control pressure gauge and shut off valve:	MO22D with C1
To protect the pump against excessive outlet pressures or to limit the outlet pressure, a safety valve can be fitted to the air control unit in the air drive line.	MO22D with C1/SV-air (The required outlet pressure has to be indicated.)

Please consult factory for more information. All technical and dimensional information subject to change. All General Terms and Conditions of sale, including limitations of our liability, apply to all products and services sold.



Leistungsdiagramm/Performance Graph M(O) 22 D

Prüfflüssigkeit/Test Liquid: Wasser-Öl-Emulsion/Water Oil Emulsion ca. 1 - 10 cst

